



JESSOPS  
*Magazine* ➤

THE  
COUNTRY  
➤ HOUSE  
DEPT.





# JESSOPS

Mountnessing Road, Blackmore, Ingatestone, CM4 0NX



Set within some 7.25 acres in the heart of the Essex countryside, Jessops is an elegant Grade II listed Georgian house, its handsome façade softened each spring by a magnificent sweep of wisteria.

Dating from the early nineteenth century, the house has been meticulously restored and thoughtfully refined by its current owners in collaboration with Nicolas Jacob Architects and Cubitt Theobald, specialists in period property. Their approach was careful and considered, preserving the character of the house while quietly enhancing it for modern living. Original features have been beautifully restored throughout, from period radiators and traditional shutters to the historic house bell, returned to working order by the renowned Whitechapel Bell Foundry, whose craftsmen traced it back to their workshops in the nineteenth century.

Inside, the rooms are elegantly proportioned and flooded with natural light. Tall sash windows frame views across the gardens and courtyard, drawing the outside gently into the house, while handmade oak cabinetry and underfloor heating in the kitchen and utility bring comfort while remaining entirely in keeping with the house.

Upstairs, the bedrooms enjoy views across the surrounding countryside, with the principal suite offering a particularly peaceful retreat. The gardens have been thoughtfully composed. A charming courtyard garden centres around ancient olive trees, while spring brings a beautiful display of tulips and alliums, followed by fragrant David Austin roses as summer unfolds.

Beyond, the grounds open out to meadow and a wonderful pool complex, perfect for everyday life and entertaining guests, with further buildings providing an annexe, garaging and stabling. Jessops is simply an exceptional house.







# THE FINER *Details*

## Bedrooms

5

## Reception Rooms

3

## Bath/Shower Rooms

3

Double Garage, Gym/ cinema room, Indoor Pool complex, Outbuildings  
6 Stables, Tack Room and Store, Koi Pond

## Acreage

7.25

## What3Words

///insect.prom.sleeps

## Co-Ordinates

51°40'55"N , 000°19'24"E

## Services

Oil Fired Central Heating  
Private Drainage - Sewage Treatment Plant  
Mains Water & Electricity

## Listing

Grade II

## EPC

F

## Council Tax

Band G

## Local Authority

Brentwood





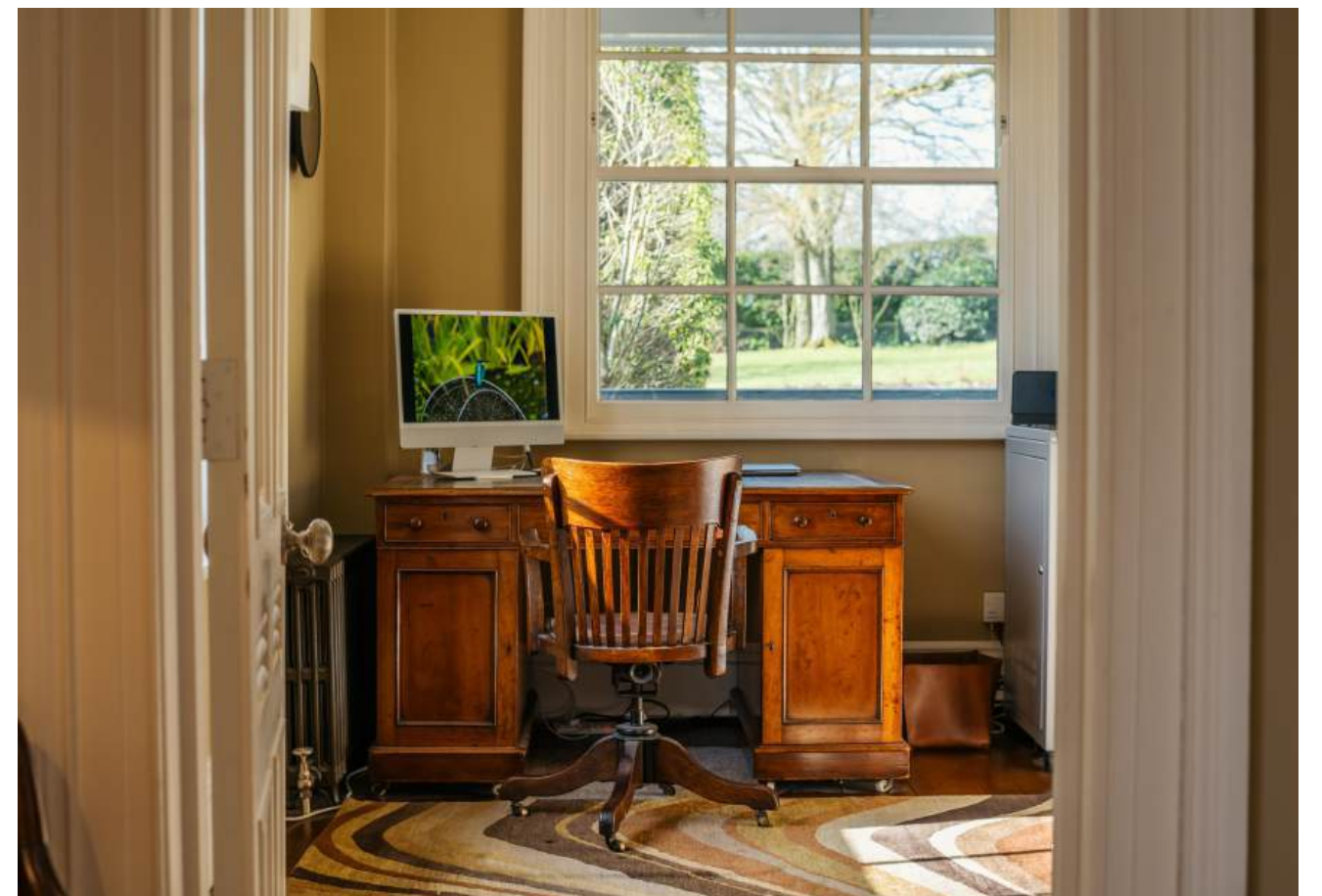







# ABOUT THIS *Area*



Jessops sits in a particularly attractive pocket of Essex countryside, close to the sought after villages of Blackmore, Fryerning and Ingatestone. The villages offer a strong sense of community with independent shops, cafés, pubs and everyday amenities.

Nearby Brentwood provides a lively town centre with an excellent selection of boutiques, coffee shops, restaurants and supermarkets, while Chelmsford offers more extensive shopping and leisure facilities.

The area is also well known for its exceptional places to eat. Local favourites include Smith's of Ongar, Felix in Warley and Alec's Restaurant in Brentwood, widely regarded as some of the finest dining destinations in Essex.

For families, the area offers excellent schooling, with highly regarded state options including Anglo European School in Ingatestone, Shenfield High School, St Martin's School in Shenfield, Brentwood Ursuline Convent High School and the renowned grammar schools for boys and girls in Chelmsford. Outstanding independent schools nearby include Brentwood School, New Hall and Felsted.

The surrounding countryside offers wonderful walking and cycling, with Weald Country Park's historic deer park and beautiful bluebell woods just a short distance away, and plenty of country walks on your doorstep.

For commuting, Shenfield Station and Ingatestone provide fast services to London Liverpool Street and Elizabeth Line connections through central London to Heathrow Airport, with easy access to the A12 and M25.















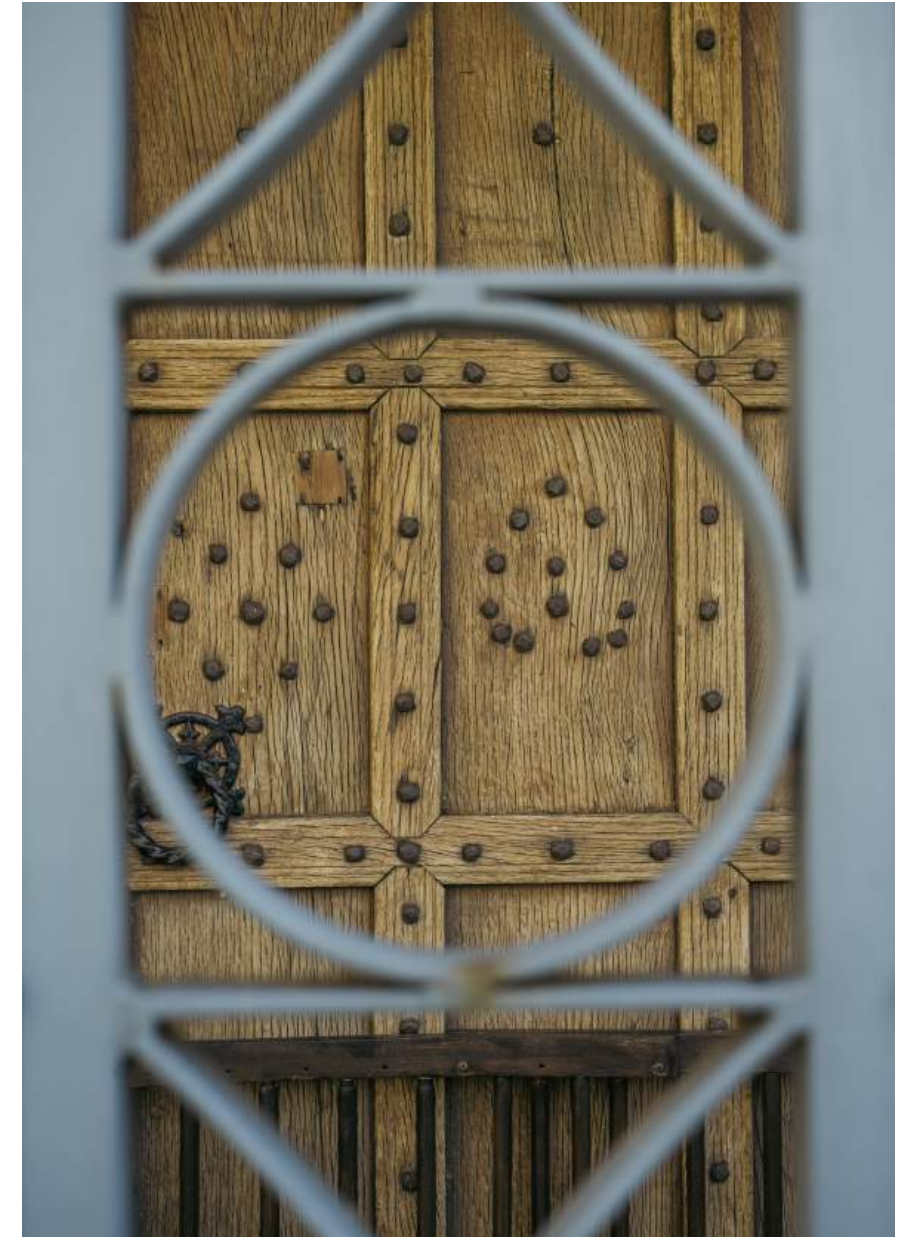



# POINTS OF *Interest*



## **Towns and Cities**

Chelmsford 10 miles  
Brentwood 5.5 miles  
Central London 35.5 miles

## **Pubs & Restaurants**

Smiths of Ongar, Ongar  
Felix Restaurant, Warley  
The Cricketers, Fryerning  
Alec's, Brentwood

## **Train Stations**

Ingatstone Station 4 miles  
Liverpool Street from 29 mins  
Shenfield Station 4.5miles  
Liverpool Street from 23 mins

## **Airports**

Southend Airport 27 miles  
Stansted Airport 23 miles  
London Heathrow 54 miles



# FLOORPLANS

## Jessops

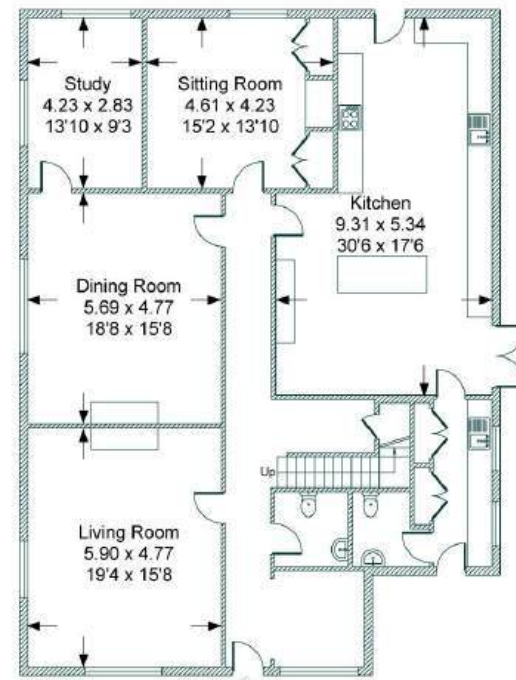
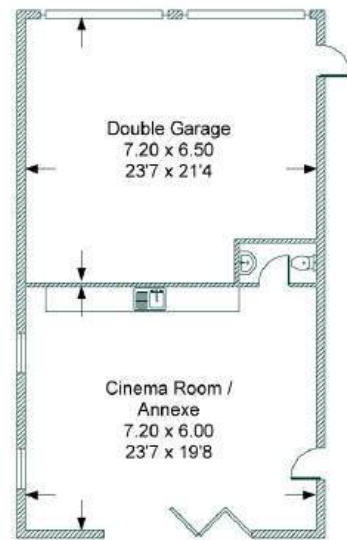
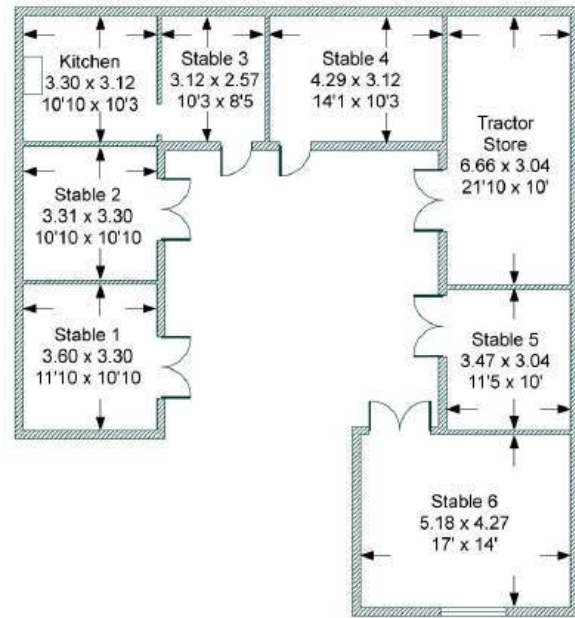

Ground Floor IN

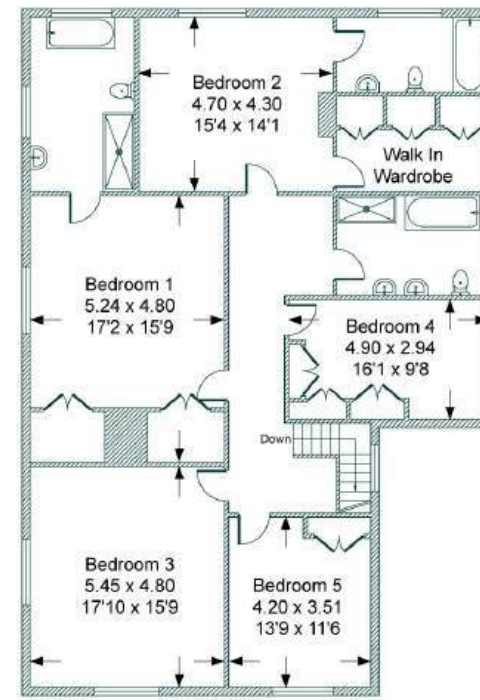

First Floor

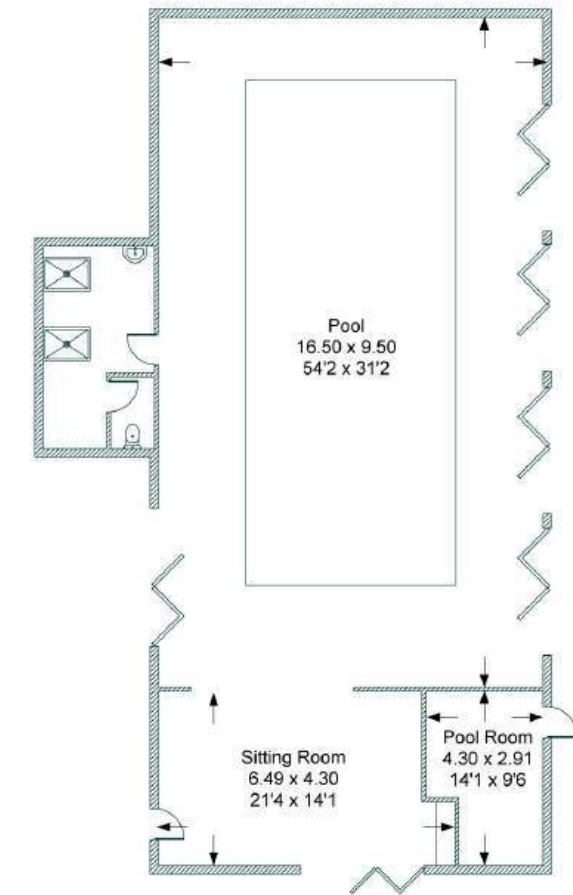

Surveyed and drawn in accordance with the International Property Measurement Standards (IPMS 2: Residential)  
Produced by The Country House Department Limited

Total - 751.1 sq m / 8,091 sq ft  
House - 340 sq m / 3,660 sq ft | Garage / Cinema - 90.6 sq m / 976 sq ft | Outbuildings - 320.9 sq m / 3,455 sq ft

# AREA GUIDE

## *Essex* 🏡

Essex is a county of contrasts, where vibrant towns and tranquil countryside meet. To the south, the coastline stretches with estuaries, beaches, and sailing hubs, while inland villages like Finchingfield and Thated showcase quintessential rural England. Colchester, Britain's oldest recorded town, is alive with Roman history, while Chelmsford brings modern energy and excellent shopping. The county has a thriving food and drink culture, from waterside seafood shacks to elegant restaurants. Nature reserves along the coast attract birdwatchers and walkers, while Dedham Vale, immortalised by Constable, offers some of the country's most idyllic landscapes. With fast rail links into London, Essex provides both commuter convenience and a surprisingly rich tapestry of countryside, history, and coastline.

### **Walk - Danbury Common**

Featuring 45 acres of grade II listed park and gardens with lakes, ancient woodland, wildflower meadow and historic features. Ideal for walking, families and picnics with friends. Danbury ridge, the highest point in Essex.

### **Event - The Essex Show**

The Essex Show celebrates local rural life, showcasing the best of agriculture, equestrian events, local food, and country pursuits, from livestock displays to showjumping and artisan stalls.

### **Day Out - RHS Hyde Hall**

A family-friendly garden, situated in the heart of rural Essex, with stunning panoramic views of the surrounding countryside, Hyde Hall is one of the finest gardens in the East of England. Encompassing a diverse mix of garden styles from traditional to modern,





THE  
COUNTRY  
HOUSE  
DEPT.



03332 340 901  
[info@thecountryhousedepartment.com](mailto:info@thecountryhousedepartment.com)  
[thecountryhousedepartment.com](http://thecountryhousedepartment.com)

IMPORTANT NOTICE: The Country House Department gives notice that: 1. These particulars do not constitute an offer or contract or part thereof. 2. All descriptions, photographs and plans are for guidance only and should not be relied upon as statements or representations of fact. All measurements are approximate and not necessarily to scale. Any prospective purchaser must satisfy themselves of the correctness of the information within the particulars by inspection or otherwise. 3. The Country House Department does not have any authority to give any representations or warranties whatsoever in relation to this property (including but not limited to planning/building regulations), nor can it enter into any contract on behalf of the Vendor. 4. The Country House Department does not accept responsibility for any expenses incurred by prospective purchasers in inspecting properties which have been sold, let or withdrawn. 5. The property will be sold subject to and with the benefit of all wayleaves, covenants, easements and rights of way, whether mentioned in these particulars or not. Photographs taken April 2026. Particulars prepared in April 2026.